

COMMUNICATION SPECIFICATION

PRODUCT : 42" WIDE PLASMA DISPLAY PANEL

**MODEL NAME : PDS4229J-B
PDS4229W-B
PDS4229E-B**

April 11, 2002

Fujitsu General Ltd.

Contents

1. Application Range -----	3
2. Communication Specification -----	3
3. Connection with Personal Computer -----	3
4. Communication Procedure -----	4
4-1 Control format -----	4
4-1-1 Communication start command -----	4
4-1-2 Communication command -----	4
4-1-3 Status -----	5
4-1-4 Communication termination command -----	5
4-2 Protocol procedure example -----	6
5. Function List -----	7
6. Supplement -----	17
CHART.Details of display character code of on screen character.(8page)	

1. Application Range

This specification applies to the control of 42" Wide Plasma Display Panel (Hereafter, referred to as PDP) with DTE terminal (Personal computer, etc., and hereafter, referred to as PC). Refer to User's Manual for the details of the function.

2. Communication Specification

The control of PDP with PC uses the RS-232C interface.

PC sends each control command to PDP, and PDP can execute the function described in the function list.

Basically, procedure structure is 'Handshake in which it starts with @G and terminates with @Q'. As a rule, the time-sharing by which the answering from PDP is monitored is used.

- Communication parameter

Baud rate	4800 BPS
Data length	8 bits
Parity	None
Stop bit	1 bit
Flow control	RTS/ CTS
Communication code	ASCII code
Reception time out	4 seconds
	When status is not returned after sending the command, wait for the time out 4 seconds and send the command again.

3. Connection with PC

When using the DOS/V compatible machine, connect with it by the straight D-SUB 9 pins cable.

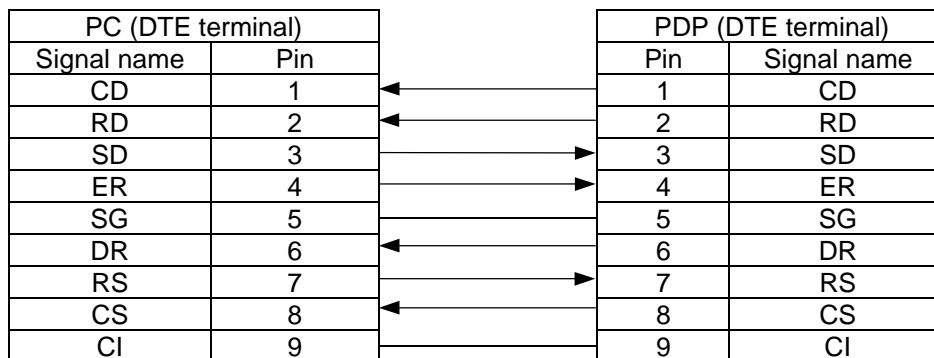

4. Communication Procedure

The handshake system is used for the communication between PC and PDP, and the status is returned against the command sending.

Moreover, PC sends the communication start command and the communication termination command at the start and termination of the communication.

The key of the remote control and the main unit becomes a disabling condition (does not function) because the communication has the priority when the communication starts after the @Q communication mode terminates.

4-1. Control format

The command and the reception status consist of ASCII code, and this specification describes it by the character string.

4-1-1. Communication start command

The communication starts.

@	G	Cr
---	---	----

When this command is sent a text communication mode start, and the communication command described in 'Function list' in clause 5 can be accepted. Wait for the normal reception status after sending this command.

However, resend it even if reception status is not received for 4 seconds.

Resend it until returning the normal reception status because irregular data or 'irregular data + reception status' might return after sending the start command. Cr means Carriage Return.

4-1-2. Communication command

Command system

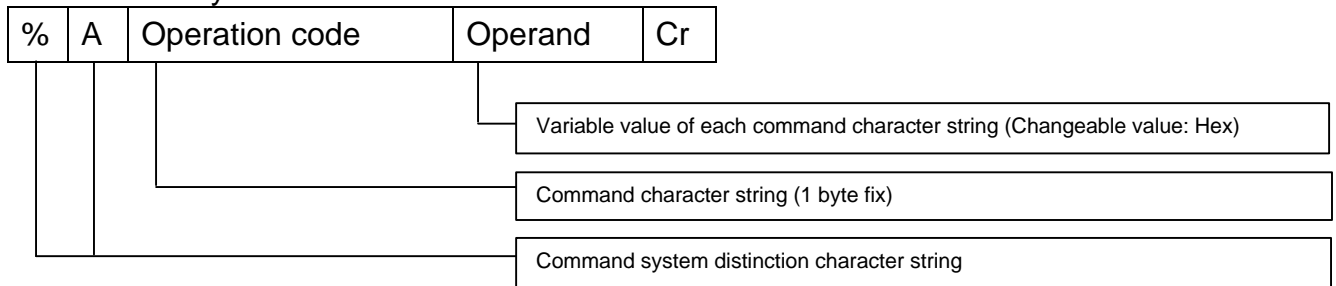

4-1-3. Status

Normal termination

@	S	Cr
---	---	----

PDP returns the status to PC after PDP normally execute the command sent by PC.

Normal termination with condition data

@	S	DT	Cr
---	---	----	----

PDP sends the operating condition to PC after PC sends the condition reading command.

(Refer to 'Function list' in clause 5 for details of a reading command and above-mentioned DT value character string.)

Abnormal termination

@	E	ST	Cr
---	---	----	----

PDP sends it to PC if PDP does not normally execute the command sent by PC. Above-mentioned ST value character string:

01: Communication error (For example, the cable is not correctly connected.)

02: Setting error (For example, the command is not correctly sent.)

03: Function execute error (For example, PDP fails in the execute of the command.)

4-1-4. Communication termination command

The communication mode terminates.

@	Q	Cr
---	---	----

4-2. Protocol procedure example

The protocol procedure example is as follows.

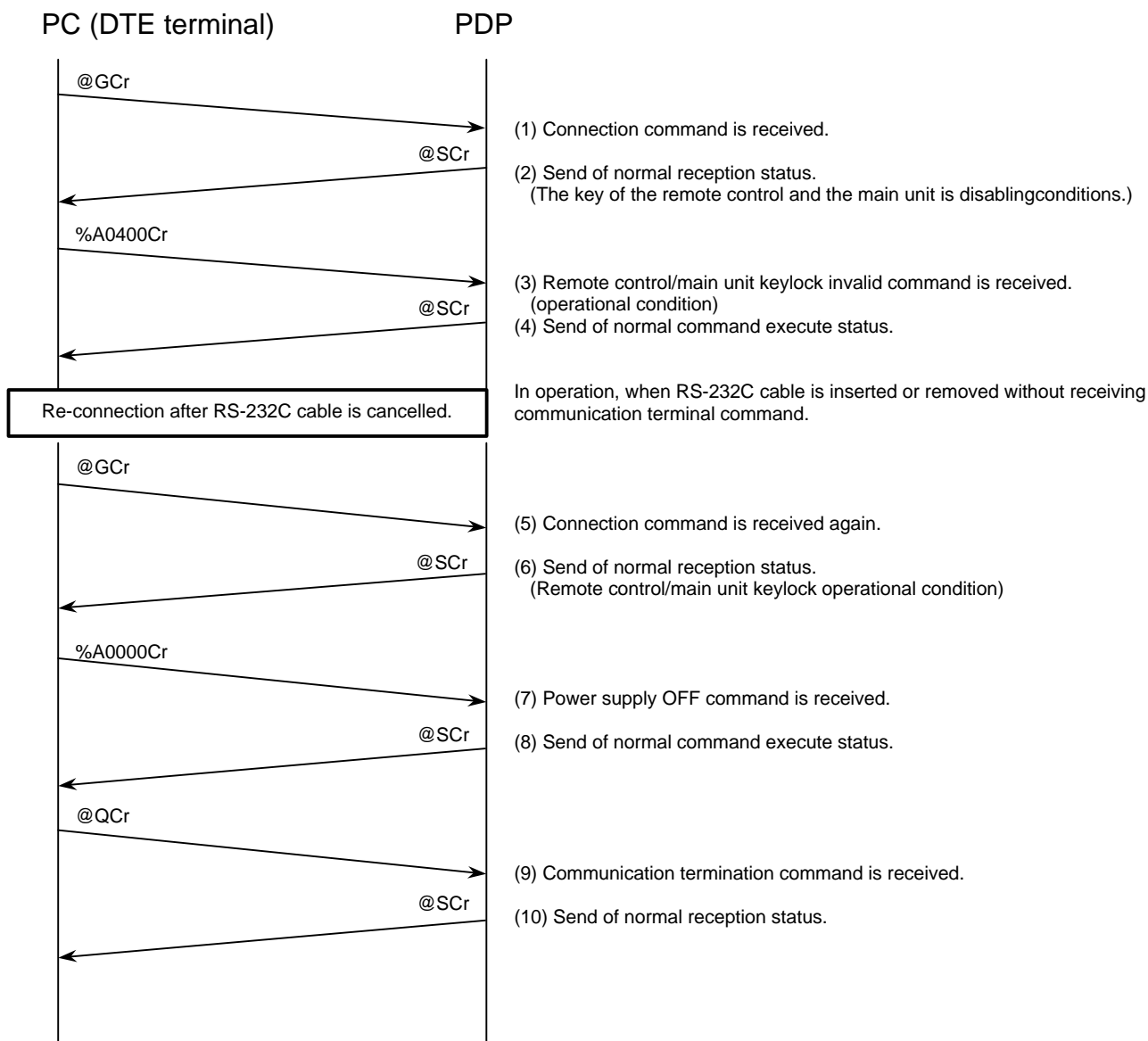

Communication code(hexadecimal) of protocol procedure example.

@GCr	=40 47 0D
@SCr	=40 53 0D
%A0400Cr	=25 41 30 34 30 30 0D
%A0000Cr	=25 41 30 30 30 30 0D
@QCr	=40 51 0D

5. Function List

'Cr' is added at the end of all communication commands. Moreover, variable value means the hex. And only the command of "Power supply On/Off setting" and "Power supply condition reading" is controllable by the power supply standby state.

A power supply standby state shows the state of "Power supply condition Off: @S00"

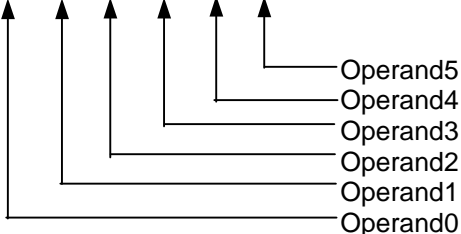
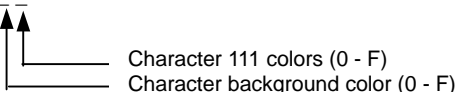
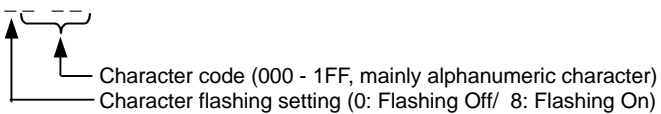
Function		Communication command	Note
01	Power supply On/ Off setting	Power supply Off: %A0000 Power supply On: %A0001	
	Power supply condition reading	%A0080 (Return Code) Power supply condition Off: @S00 Power supply condition On: @S01	
02	On screen automatic display On/ Off setting	%A0100: Automatic display Off %A0101: Automatic display On	OSD display setting
	On screen automatic display On/Off set condition reading	%A0180 (Return Code) @S00: Automatic display condition Off @S01: Automatic display condition On	
03	On screen character clear	%A02	
04	On screen character display (A specified character is superimposed on the screen)	%A03  <p>(Operand0) The coordinate of horizontal character Setting range: 00 - 1D</p> <p>(Operand1) The coordinate of vertical character Setting range: 00 - 0F</p> <p>(Operand2) Character background color/ Character color Setting range:</p>  <p>(Operand3) The number of characters Setting range: 01 - 0F (15 characters or less)</p> <p>(Operand4) (Operand5) Character code Setting range:</p>  <p>(Operand4) and (Operand5) are added according to the number of characters of (Operand3). Example) The flashing display of "A" in red color on the black background at coordinate (0.0) is %A03000004018041. Note) - Pay attention to the screen burn-in by the fixed display for a long time. - The display of this function is cleared by the OSD display with the key of remote control and the main unit (including communication control).</p>	Refer to supplement 6-1 for details of the coordinate.
		Refer to supplement 6-2 for details of the color number.	
			Refer to CHART. for details of the character-code.

Function		Communication command	Note
05	Setting of remote control/main unit keylock function	Remote control keylock is invalid and main unit keylock is invalid. : %A0400 Remote control keylock is invalid and main unit keylock is valid: %A0401 Remote control keylock is valid and main unit keylock is invalid: %A0402 Remote control keylock is valid and main unit keylock is valid: %A0403	Note) When the communication is started again after the termination of the communication, the remote control key and the main unit key become a disabling condition (does not function) for the priority of the communication.
	Confirmation of remote control/main unit keylock setting	%A0480 (Return Code) @S00: Remote control keylock invalid Main unit keylock invalid @S01: Remote control keylock invalid Main unit keylock valid @S02: Remote control keylock valid Main unit keylock invalid @S03: Remote control keylock valid Main unit keylock valid	
06	Initialization of user adjustable value	%A05	Factory Default
07	Video input selection	RGB input: %A1000 Comp. Video input: %A1010 Video input: %A1012 S-video input: %A1014	
	Video input select condition reading	%A1080 (Return Code) @S00: RGB input @S10: Comp. video input @S12: Video input @S14: S-video input	
08	Display aspect selection	Normal: %A1100	When Comp. video is selected and 720P or HDTV is input, this command is not accepted.
		Wide1: %A1101	When RGB or Comp. video is selected and 720P or HDTV is input, this command is not accepted.
		Wide2: %A1102	When RGB or Comp. video is selected and 720P or HDTV is input, 'Wide' is displayed.
		Zoom1: %A1103	When RGB or Comp. video is selected and 720P or HDTV is input, 'Zoom' is displayed.
	Zoom2: %A1104	When RGB or Comp. video is selected and 720P or HDTV is input, this command is not accepted.	
Display aspect select condition reading	%A1180 (Return Code) @S00: Normal @S01: Wide1 @S02: Wide2 (When RGB or Comp. Video is selected and 720P or HDTV is input, it is 'Wide'.) @S03: Zoom1 (When RGB or Comp. Video is selected and 720P or HDTV is input, it is 'Zoom'.) @S04: Zoom2		

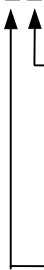
Function		Communication command	Note
09	Video system setting	%A12_ _  <p>(video input) 0: NTSC (60Hz) 1: PAL60 (60Hz) 2: 4.43NTSC (60Hz) 4: PAL (50Hz) 6: SECAM (50Hz) 8: AUTO</p> <p>(S video input) 0: NTSC (60Hz) 1: PAL60 (60Hz) 2: 4.43NTSC (60Hz) 4: PAL (50Hz) 6: SECAM (50Hz) 8: AUTO</p>	

Function		Communication command	Note
Video adjustment			
10	Contrast	%A130062 - %A13009E (Reference value: %A130080)	PDP adjustable range: -30 - +30
	Contrast condition reading	%A1380 (Return Code) @S62 - @S9E	
11	Brightness	%A130144 - %A1301BC (Reference value: %A130180)	PDP adjustable range: -60 - +60
	Brightness condition reading	%A1381 (Return Code) @S44 - @SBC	
12	Color (Excluding RGB).	%A130244 - %A1302BC (Reference value: %A130280)	PDP adjustable range: -60 - +60
	Color condition reading (Excluding RGB).	%A1382 (Return Code) @S44 - @SBC	
13	Tint (Excluding RGB).	(When Video or S-video is selected) %A130362 - %A13039E (Reference value: %A130380)	PDP adjustable range: -30 - +30
		(When Comp. video is selected) %A130344 - %A1303BC (Reference value: %A130380)	PDP adjustable range: -60 - +60
	Tint condition reading (Excluding RGB).	%A1383 (Return Code) @S62 - @S9E: When Video or S-video is selected. @S44 - @SBC: When Comp. video is selected.	
14	Sharpness	(When Video, S-video, Comp. video, or RGB decoder is selected.) %A130470 - %A130490 (Reference value: %A130480)	PDP adjustable range: -16 - +16
		(When RGB-PC is selected.) %A13047C - %A130484 (Reference value: %A130480)	PDP adjustable range: -4 - +4
	Sharpness condition reading	%A1384 (Return Code) @S70 - @S90: When Video, S-video, Comp. video, or RGB Decoder is selected. @S47 - @S84: When RGB-PC is selected.	
15	Color temperature (Color Temp.)	Warm : %A130600	
		Standard : %A130601	
		Cool : %A130602	
		User : %A130603	
	Color temperature condition reading	%A1386 (Return Code) @S00 : Warm @S01 : Standard @S02 : Cool @S03 : User	
16	User Color temperature(R) (User Color Temp.)	%A130700 - %A1307FF	PDP adjustable range: 0 - 255
	User Color temperature (R) condition reading	%A1387 (Return Code) @S00 - @SFF	
17	User Color temperature(G) (User Color Temp.)	%A130800 - %A1308FF	PDP adjustable range: 0 - 255
	User Color temperature (G) condition reading	%A1388 (Return Code) @S00 - @SFF	
18	User Color temperature(B) (User Color Temp.)	%A130900 - %A1309FF	PDP adjustable range: 0 - 255
	User Color temperature (B) condition reading	%A1389 (Return Code) @S00 - @SFF	

Function		Communication command	Note
Video adjustment			
19	Dot clock (Only RGB)	%A130A44 - %A130ABC (Reference value: %A130A80)	PDP adjustable range: -60 - +60
	Dot clock condition reading (Only RGB).	%A138A (Return Code) @S44 - @SBC	
20	Clock phase (Only RGB).	%A130B00 - %A130B1F Automatic adjustment: %A130B80	PDP adjustable range: 1 - 32
	Clock phase condition reading (Only RGB)	%A138B (Return Code) @S00 - @S1F When automatic adjustment, it is @S80 - @S9F.	
21	Vertical synchronizing signal correction (Only RGB) (Vertical Sync)	%A130C7F - %A130C81 (Reference value: %A130C80)	PDP adjustable range: -1 - +1
	Vertical synchronizing signal correction condition reading (Only RGB)	%A138C (Return Code) @S7F - @S81	
22	Clamp pulse position (Only RGB and Comp.Video). (Clamp Position)	%A130D78 - %A130D88 (Reference value: %A130D80)	PDP adjustable range: -8 - +8
	Clamp pulse position condition reading (Only RGB and Comp.Video).	%A138D (Return Code) @S78 - @S88	
23	Gamma correction change (Gamma)	Static: %A130F00	The function is not provided in a video system.
		Dynamic1: %A130F01	
		Dynamic2: %A130F02	
	Dynamic3: %A130F03		
Gamma correction change condition reading	%A138F (Return Code) @S00 : Static @S01 : Dynamic1 @S02 : Dynamic2 @S03 : Dynamic3		
24	Gradation change (Only RGB) (Gradation)	Motion: %A131000 Still: %A131001	
	Gradation change condition reading (Only RGB)	%A1390 (Return Code) @S00 : Motion @S01 : Still	
25	Auto calibration (Only RGB)	Execute (execute): %A131200	
		Original (Factory shipping value): %A131201	

Function		Communication command	Note
Video position/ size setting			
26	Video horizontal position setting (Horizontal Position)	(When RGB is selected.) %A1400076A - %A14000896 (Reference value: %A14000800)	PDP adjustable range: -150 - +150
		(When Comp. video is selected, and SDTV, 525P, or 625P is input.) %A140007F0 - %A14000810 (Reference value: %A14000800)	PDP adjustable range: -16 - +16
		(When Comp. video is selected, and 720P or HDTV is input.) %A140007E0 - %A14000820 (Reference value: %A14000800)	PDP adjustable range: -32 - +32
		(When Video or S-video is selected.) %A140007E2 - %A1400081E (Reference value: %A14000800)	PDP adjustable range: -30 - +30
	Video horizontal position condition reading	%A1480 (Return Code) @S076A - @S0896	
27	Video vertical position setting (Vertical Position)	(When RGB is selected.) %A1401076A - %A14010896 (Reference value: %A14010800)	PDP adjustable range: -150 - +150
		(When Comp. video is selected, and SDTV, 525P, or 625P is input.) %A140107F0 - %A14010810 (Reference value: %A14010800)	PDP adjustable range: -16 - +16
		(When Comp. video is selected, and 720P or HDTV is input.) %A140107E0 - %A14010820 (Reference value: %A14010800)	PDP adjustable range: -32 - +32
		(Video and S-video. Screen size Normal, Wide1, or Wide2 is selected.) %A140107F9 - %A14010807 (Reference value: %A14010800)	PDP adjustable range: -7-+7
	(Video and S-video. Screen size Zoom1 or Zoom2 is selected.) %A140107F1 - %A1401080F (Reference value: %A14010800)	PDP adjustable range: -15 - +15	
Video vertical position condition reading	%A1481 (Return Code) @S076A - @S0896		
28	Video horizontal width setting (Horizontal Size)	(When RGB is selected.) %A140267 - %A1402B2 (Reference value: %A140280)	PDP adjustable range: -25 - +50
		(When Comp. video is selected.) %A14027C - %A140284 (Reference value: %A140280)	PDP adjustable range: -4 - +4
		(When Video or S-video is selected.) %A140279 - %A140287 (Reference value: %A140280)	PDP adjustable range: -7 - +7
	The video horizontal width condition reading	%A1482 (Return Code) @S67 - @SB2	
29	Video vertical height setting (Vertical Size)	(When RGB is selected.) %A140367 - %A1403B2 (Reference value: %A140380)	PDP adjustable range: -25 - +50
		(When Comp. video is selected.) %A14037C - %A140384 (Reference value: %A140380)	PDP adjustable range: -4 - +4
		(When Video or S-video is selected.) %A140379 - %A140387 (Reference value: %A140380)	PDP adjustable range: -7-+7
	Video vertical height condition reading	%A1483 (Return Code) @S67 - @SB2	

Function		Communication command	Note
Extended features			
30	OSD Rotate display (OSD Rotate)	Standard (horizontal putting): %A310000	The remote control receiver is put at the lower position.
		+90 degree rotation: %A310001	
		-90 degree rotation: %A310002	The remote control receiver is put at the upper position.
	OSD Rotate display condition reading	%A3180 (Return Code) @S00: Standard (horizontal putting) @S01: +90 degree rotation @S02: -90 degree rotation	
31	Language selection	English: %A310100	
		German: %A310101	
		Spanish: %A310102	
		French: %A310103	
		Italian: %A310104	
		Portuguese: %A310105	
		Russian: %A310106	Only PDS4229E
	Language select condition reading	%A3181 (Return Code) @S00: English @S01: German @S02: Spanish @S03: French @S04: Italian @S05: Portuguese @S06: Russian	
32	DPMS setting	DPMS OFF : %A310200	
		Black background. 1 minute: %A310201	
		Black background. 15 minutes: %A310202	
		Black background. 45 minutes: %A310203	
		Black background. 60 minutes: %A310204	
		White background. 1 minute: %A310281	
		White background. 15 minutes: %A310282	
		White background. 45 minutes: %A310283	
		White background. 60 minutes: %A310284	
	DPMS set Condition reading	%A3182 (Return Code) @S00: DPMS Off @S01: Black background. 1 minute. @S02: Black background. 15 minutes. @S03: Black background. 45 minutes. @S04: Black background. 60 minutes. @S81: White background. 1 minute. @S82: White background. 15 minutes. @S83: White background. 45 minutes. @S84: White background. 60 minutes.	
33	White screen display	White screen display Off: %A310300	
		White screen display On: %A310301	
	White screen display condition reading	%A3183 (Return Code) @S00: White screen display Off @S01: White screen display On	

Function		Communication command	Note
Extended features			
34	Screen orbiter setting (Only RGB) (Screen Orbiter)	Screen orbiter Off: %A310401	
		Minimum turn at constant intervals: %A310410	About 5dots orbiter
		Standard turn at constant intervals: %A310411	About 10dots orbiter
		Maximum turn at constant intervals: %A310412	About 15dots orbiter
		Minimum turn at each mode change: %A310420	About 5dots orbiter
		Standard turn at each mode change: %A310421	About 10dots orbiter
		Maximum turn at each mode change: %A310422	About 15dots orbiter
	Screen orbiter condition reading	%A3184 (Return Code) @S01: Screen orbiter Off @S10: Minimum turn at constant intervals @S11: Standard turn at constant intervals @S12: Maximum turn at constant intervals @S20: Minimum turn at each mode change @S21: Standard turn at each mode change @S22: Maximum turn at each mode change	
35	Input priority	Off: %A310500	
		RGB: %A310502	
		Video: %A310504	
		S-video: %A310505	
		Comp. video: %A310507	
	Input priority condition reading	%A3185 (Return Code) @S00: Off @S02: RGB @S04: Video @S05: S-video @S07: Comp. video	
36	Monitor number Setting (Monitor No.)	Off: %A310600	
		1: %A310601	
		2: %A310602	
		3: %A310603	
		4: %A310604	
	Monitor number Set condition reading	%A3186 (Return Code) @S00: Off @S01: 1 @S02: 2 @S03: 3 @S04: 4	
37	Code setting (Only RGB)	Auto: %A310780 Manual RGB parameter code: %A310700 - %A31072A	
	Code set condition reading (Only RGB)	%A3187 (Return Code) @S80 - @SAA: Auto @S00 - @S2A: Manual RGB parameter code	

Function		Communication command	Note
Extended features			
38	Direct setting (Only RGB)	Auto: %A310800	
		VGA: %A310801	
		WVGA: %A310802	
		XGA: %A310804	
	480P: %A310803		
	Direct set condition reading (Only RGB)	%A3188 (Return Code) @S00: Auto @S01: VGA @S02: WVGA @S04: XGA @S03: 480P	
39	Installation setting (Installation)	Horizontal (Horizontal putting): %A310900 Vertical (Vertical putting): %A310901	
	Installation set condition reading	%A3189 (Return Code) @S00: Horizontal (Horizontal putting) @S01: Vertical (Vertical putting)	
40	BNC input setting (BNC input)	Comp. Video Mask Off: %A310A20	
		Comp. video Mask 5 dots: %A310A21	
		Comp. video Mask 10 dots: %A310A22	
		Comp. video Mask 15 dots: %A310A23	
		BNC input set condition reading	%A318A (Return Code) @S20: Comp. video mask Off @S21: Comp. video mask 5 dots @S22: Comp. video mask 10 dots @S23: Comp. video mask 15 dots
41	RGB D-SUB input setting (D-SUB input)	RGB-PC Mask Off: %A310B00	
		RGB decoder mask Off: %A310B10	
		RGB decoder mask 5 dots: %A310B11	
		RGB decoder mask 10 dots: %A310B12	
		RGB decoder mask 15 dots: %A310B13	
		RGB D-SUB input set condition reading	%A318B (Return Code) @S00: RGB-PC mask Off @S10: RGB decoder mask Off @S11: RGB decoder mask 5 dots @S12: RGB decoder mask 10 dots @S13: RGB decoder mask 15 dots
42	Exhibition mode setting (Exhibition mode)	Off: %A310C00 On: %A310C01	
		%A318C	
	Exhibition mode set condition reading	(Return Code) @S00: Off @S01: On	

Function		Communication command	Note
Remote control code			It does not function when remote control is prohibited.
43	Power supply changes On/Off sequentially	%A3200	
44	Power supply On	%A3201	
45	Power supply Off	%A3202	
46	Input changes sequentially	%A3203	
47	Video input Changes Sequentially	%A3205	
48	Menu cursor	%A323E	
49	Menu cursor	%A323F	
50	Menu button	%A3240	
51	Menu cursor	%A3241	
52	Menu cursor	%A3242	
53	Enter	%A325B	
54	Wide changes Sequentially	%A3280	

6. Supplement

6-1. Details of display coordinate of on screen character

[Size of character]

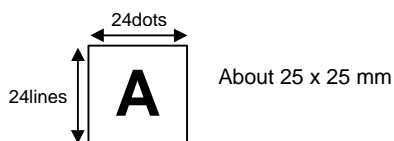

[Range of display and number of characters]

< OSD Rotate display: Normal >

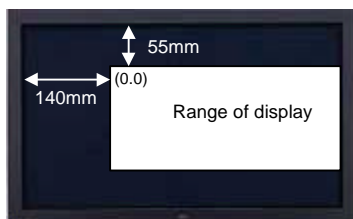

Origin of coordinates of range of display:
Upper left of the range of display of left figure
(Installation condition: 140 mm in horizontal and 55 mm
in vertical from upper left of screen)
The number of character in horizontal direction: 30 characters
The number of character in vertical direction: 16 characters

< OSD Rotate display: +90 Degree. The remote control receiver is put at the upper position. >



Origin of coordinates of range of display:
Upper left of the range of display of left figure
(Installation condition: 55 mm in horizontal and 104 mm
in vertical from upper left of screen)
The number of character in horizontal direction: 16 characters
The number of character in vertical direction: 16 characters

< OSD Rotate display: -90 Degree. The remote control receiver is put at the lower position. >





Origin of coordinates of range of display:
Upper left of the range of display of left figure
(Installation condition: 55 mm in horizontal and 120 mm
in vertical from upper left of screen)
The number of character in horizontal direction: 16 characters
The number of character in vertical direction: 16 characters

Note) A physical position of origin of coordinates (0. 0) changes by the rotation setting of OSD as shown in the above.

6-2. Details of display color number of on screen character

Color number	Color of screen	Color number	Color of screen
0	Black	8	----
1	Blue	9	Light Blue
2	Green	A	Light Green
3	Cyan	B	Light Cyan
4	Red	C	Light Red
5	Magenta	D	Light Magenta
6	Brown	E	Yellow
7	White	F	White(high intensity)

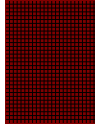
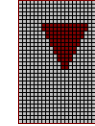
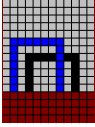
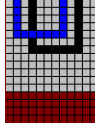
CHART.Details of display character code of on screen character.

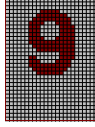
							
000	001	002	003	004	005	006	007
							
008	009	00A	00B	00C	00D	00E	00F
							
010	011	012	013	014	015	016	017
							
018	019	01A	01B	01C	01D	01E	01F
							
020	021	022	023	024	025	026	027
							
028	029	02A	02B	02C	02D	02E	02F
							
030	031	032	033	034	035	036	037
							
038	039	03A	03B	03C	03D	03E	03F

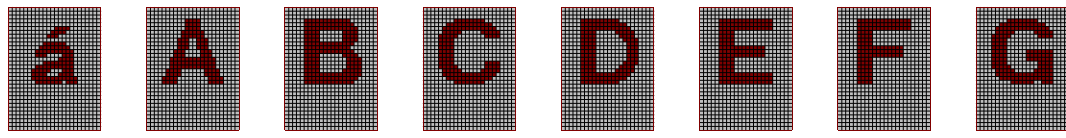

040 041 042 043 044 045 046 047

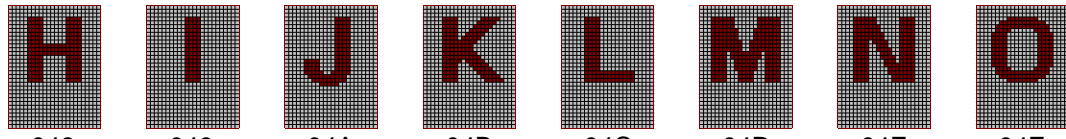

048 049 04A 04B 04C 04D 04E 04F

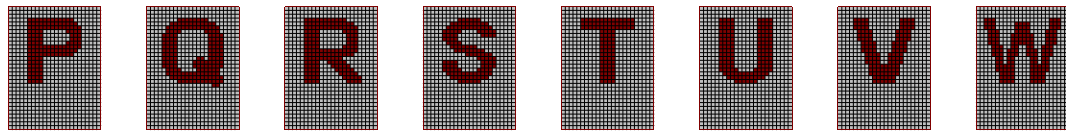

050 051 052 053 054 055 056 057

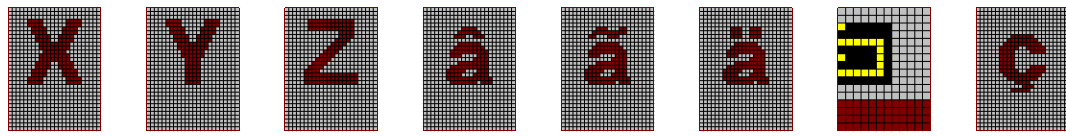

058 059 05A 05B 05C 05D 05E 05F

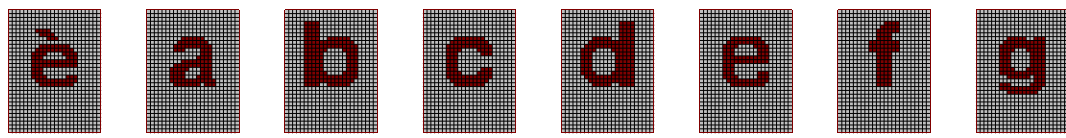

060 061 062 063 064 065 066 067

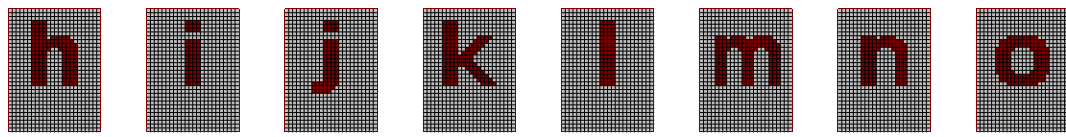

068 069 06A 06B 06C 06D 06E 06F

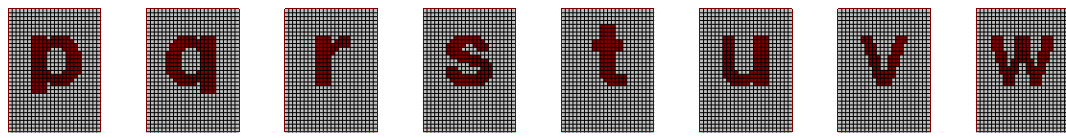

070 071 072 073 074 075 076 077

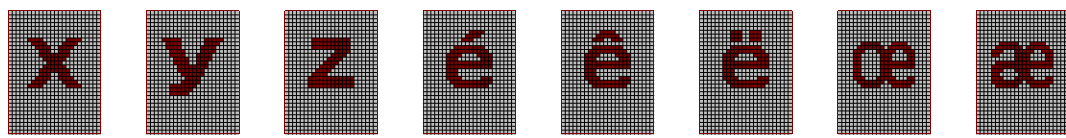

078 079 07A 07B 07C 07D 07E 07F

080	081	082	083	084	085	086	087
088	089	08A	08B	08C	08D	08E	08F
090	091	092	093	094	095	096	097
098	099	09A	09B	09C	09D	09E	09F
0A0	0A1	0A2	0A3	0A4	0A5	0A6	0A7
0A8	0A9	0AA	0AB	0AC	0AD	0AE	0AF
0B0	0B1	0B2	0B3	0B4	0B5	0B6	0B7
0B8	0B9	0BA	0BB	0BC	0BD	0BE	0BF

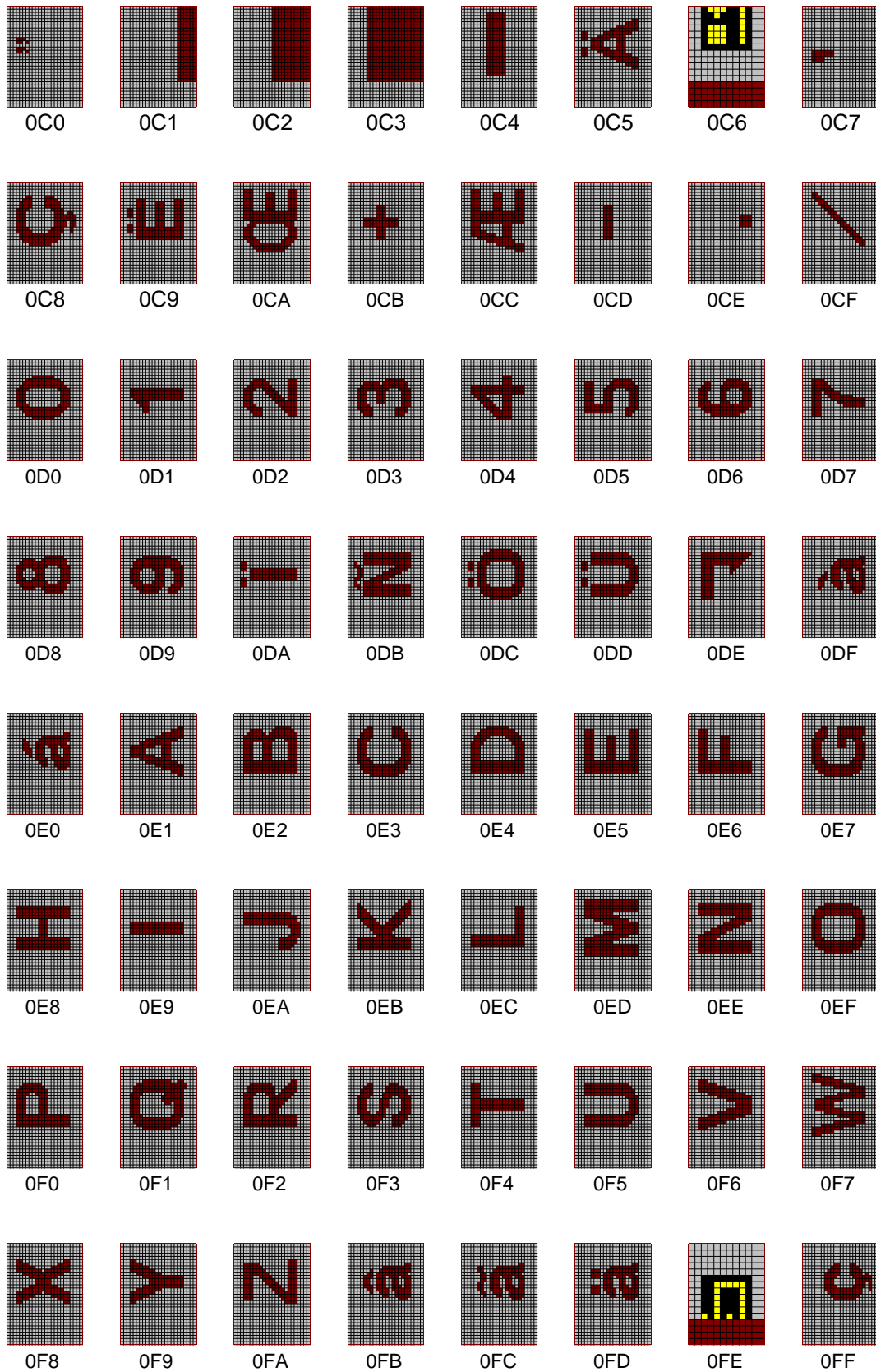

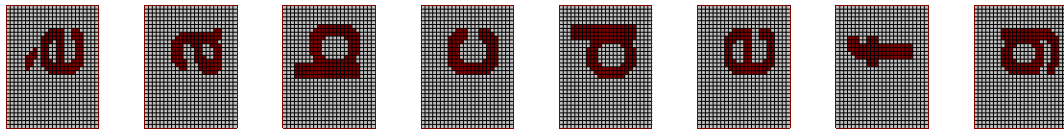

100 101 102 103 104 105 106 107

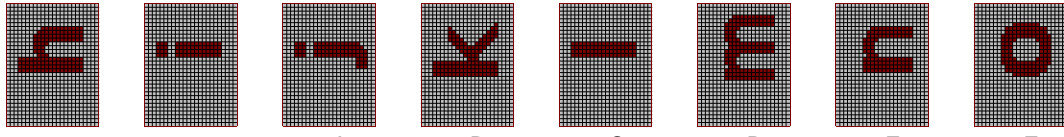

108 109 10A 10B 10C 10D 10E 10F

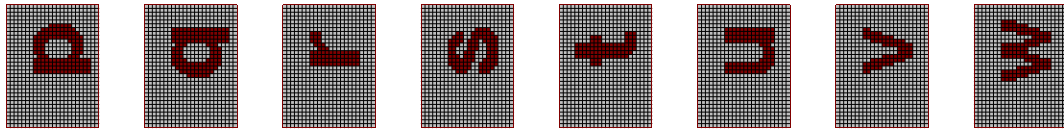

110 111 112 113 114 115 116 117

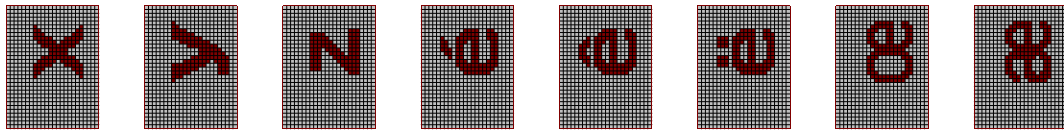

118 119 11A 11B 11C 11D 11E 11F

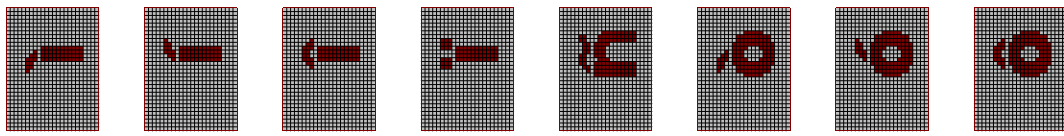

120 121 122 123 124 125 126 127

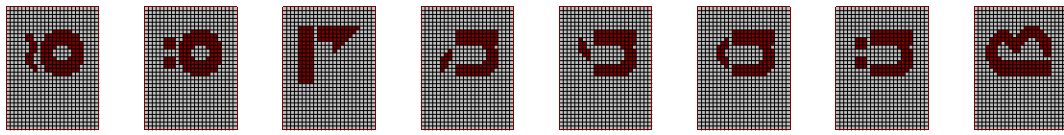

128 129 12A 12B 12C 12D 12E 12F

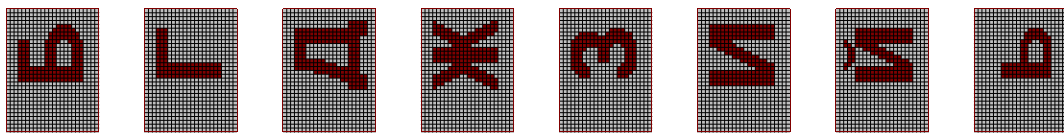

130 131 132 133 134 135 136 137

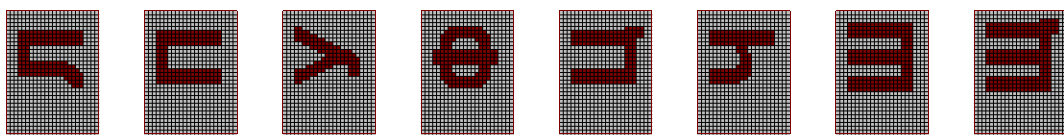

138 139 13A 13B 13C 13D 13E 13F



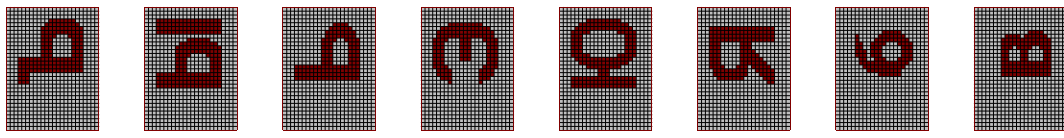

140

141

142

143

144

145

146

147

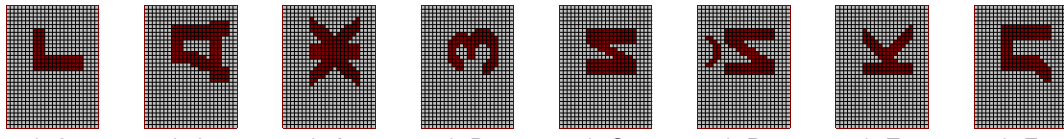

148

149

14A

14B

14C

14D

14E

14F

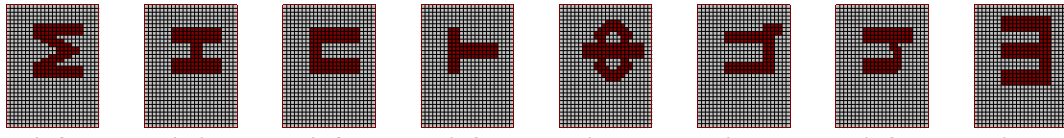

150

151

152

153

154

155

156

157

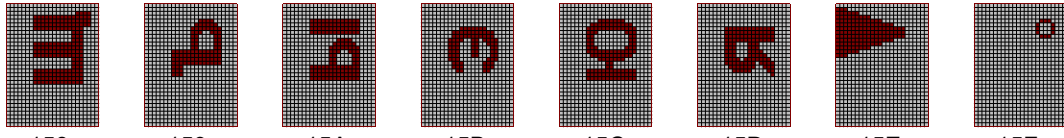

158

159

15A

15B

15C

15D

15E

15F

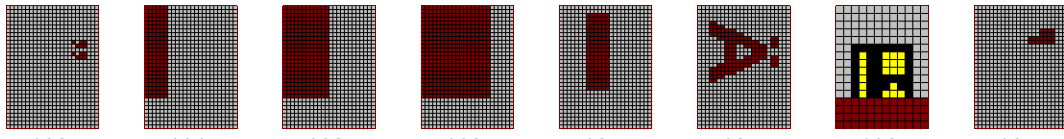

160

161

162

163

164

165

166

167

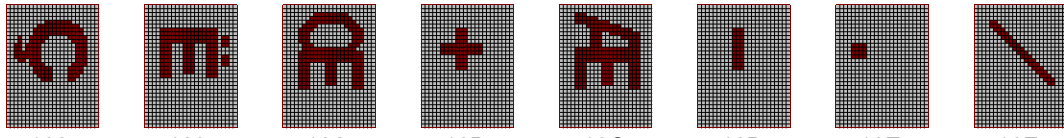

168

169

16A

16B

16C

16D

16E

16F

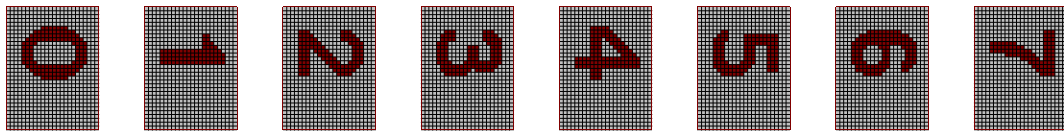

170

171

172

173

174

175

176

177

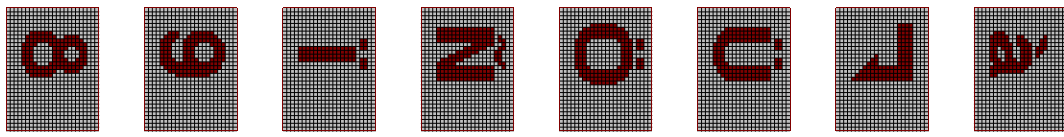

178

179

17A

17B

17C

17D

17E

17F

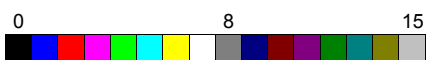

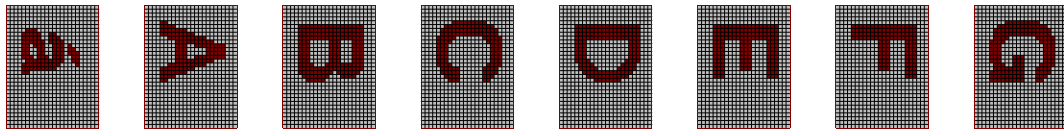

180 181 182 183 184 185 186 187

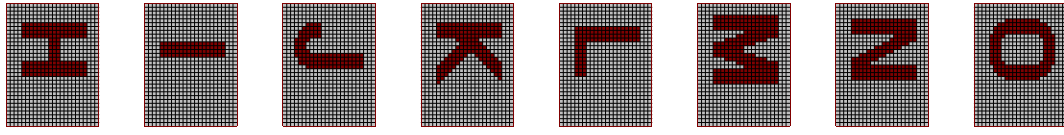

188 189 18A 18B 18C 18D 18E 18F

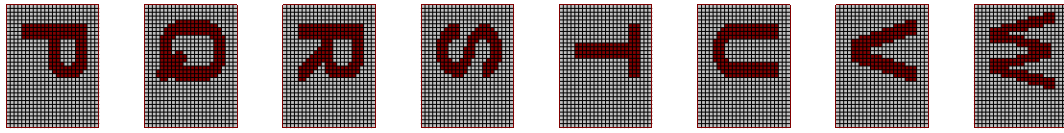

190 191 192 193 194 195 196 197

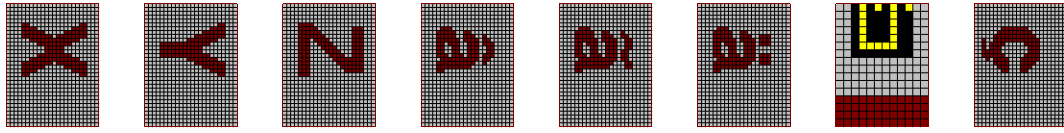

198 199 19A 19B 19C 19D 19E 19F

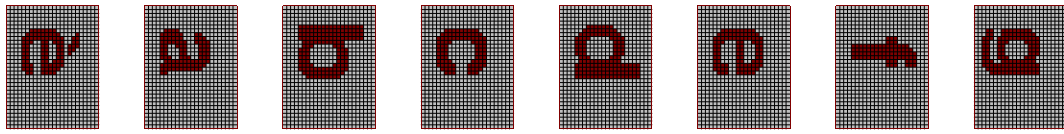

1A0 1A1 1A2 1A3 1A4 1A5 1A6 1A7

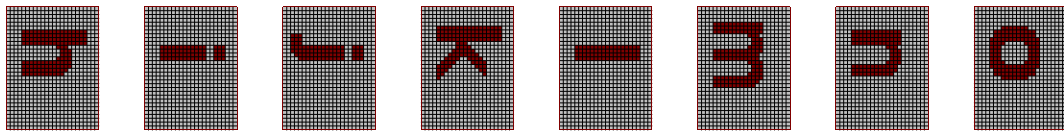

1A8 1A9 1AA 1AB 1AC 1AD 1AE 1AF

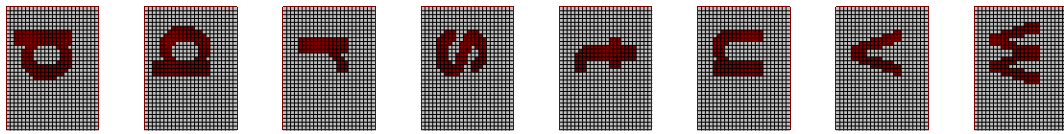

1B0 1B1 1B2 1B3 1B4 1B5 1B6 1B7

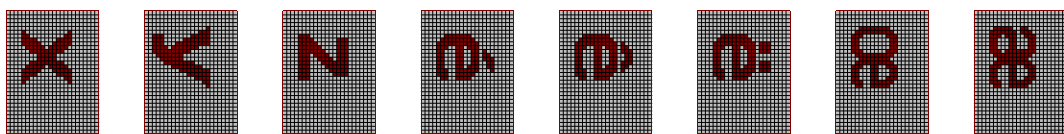

1B8 1B9 1BA 1BB 1BC 1BD 1BE 1BF

